



powerlet®

RUGGED ELECTRICAL ACCESSORIES

Designed For A Lifestyle,
Built For A Lifetime™

Our Mission:

Since 2001, Powerlet's passion has been to provide Rugged Electrical Solutions for the Powersports Industry. Designing and manufacturing our products right here in Detroit, Michigan utilizing only the highest quality materials, Powerlet strives to solve the needs of riders with solutions that work no matter what conditions you ride in. From mounting and powering your smart phone to just staying warm while riding, Powerlet can help you make it happen.

Born out of necessity and refined with our relentless passion, testing, and perpetual design, our products exceed all standards and carry a lifetime warranty. From long distance to off road riding whether you just want to power your GPS or keep your battery charged, Powerlet has you covered.

Check out our Facebook page for up-coming events to hook up with our installation tour.
Let us help you **GET IT ON!**



@powerlet



www.facebook.com/powerlet



twitter.com/powerlet

Power Solutions for your Lifestyle.

Harley® Motorcycle Riders

4-9

BMW® Motorcycle Riders / BMW® CANbus

10-13

Cruiser Motorcycle Riders

14-15

Touring / Sport Touring Motorcycle Riders

16-17

Adventure Motorcycle Riders

18-19

Off Road Motorcycle Riders

20-21

Sport Bike Riders

22-23

Powerlet® Product Line



Powerlet Outlets / Universal Kits
All Makes and Models

24-35



Power Cables / Phone Chargers
Make The Connection

36-45



Mounting Systems
Power and Mount a Gadget

46-49



Plugs, Sockets, Wiring and More
Get Wired & Go Play

50-57



Luggage Electrix
Power Everything

58-63

What is a Powerlet and why do we need it?

People rely on standard power outlets in their cars and homes to charge and power a variety of consumer electronics. Yet the majority of motorcycles and virtually all other outdoor vehicles are unable to even charge a cell phone, let alone power heated clothing without first modifying the vehicle. Powerlet makes it easy and convenient to install a Powersports Standard Connector to solve these issues.

Powerlet® & Luggage Electrix™ products are designed to be installed and/or used on Victory®, Ducati®, Harley® motorcycles, Honda®, Suzuki®, KTM®, BMW®, Kawasaki®, Aprilia®, Triumph®, Yamaha® and all other makes and models of motorcycles, ATV's, UTV's and powersport vehicles.

Choosing an outlet

Currently there are 4 outlet types that are used frequently in the Powersports industry. Your vehicle may already have one of these installed and while we support all 4 types of outlets, only the Powerlet outlet can truly do it all.

Powerlet Socket



Powersports Standard Connector (Powerlet)- This connector follows the DIN ISO Standard and has already been adopted in our industry by more than half of the manufacturers. With this outlet, the customer can easily take power out of the bike to power devices as well as putting power back in by charging the vehicles battery. The standard for this connector is 15amps that is connected directly to the battery. This is truly a "One outlet does it all" system and it's main differentiators from the other connectors are as follows:



Waterproof - Designed for a rugged outdoor environment, they will not fail after prolonged use out in the elements.



Vibration Proof - Male connectors snap in positively and offer a much better grounding connection allowing a secure connection that can still be easily unplugged by customers with gloves on.



Fuel and Oil resistant & UV Stable- All components offered from Powerlet are built with materials designed to function in the aggressive powersports environment.



UV Stable- Designed for an open canopy powersports vehicle to with stand extreme environments.

Get to know Powerlet. The standard for excellence.

The Powerlet Mark of Comfort, Convenience and Safety

The Powerlet Logo Program helps consumers make easy purchase decisions by identifying power outlets that have passed compatibility and reliability tests with the "Compatible with Powerlet 5A™" or "Compatible with Powerlet 15A™" compliance tests.

Genuine Powerlet compliance assurance strengthens consumer & Dealer confidence. Dealers can enjoy increased customer satisfaction with products that they can be confident will work for their customers. Consumers can quickly identify which vehicle is capable of charging cell phones, heated clothing, etc. Consumers realize that it's not only possible, but easy to power their consumer electronics off of their powersport vehicle.



Genuine Powerlet P5 and P15



Capable of 5 amps and suitable for smartphones, GPS, and MP3 players.



Capable of 15 amps and suitable for heated clothing, tire inflators, smartphones, GPS, and MP3 players. The genuine P15 is also capable of charging the vehicle's battery.

www.powerlet.com

GET
IT
ON

Coax



Coax Connectors – Powerlet utilizes a standard Coax 2555 connector for powering our RapidFIRE heated clothing. The majority of our competitors in this product line also utilize the same connection.

Powerlet® connectors are fully compatible with the factory power outlets found on BMW®, Triumph®, Ducati®, KTM®, Indian® and Victory® motorcycles.

Automotive



Automotive (Cigarette) Sockets – This connector is the most commonly known connector as we are used to using this type of connection in all our cars. While this connector is certainly suitable when used inside of luggage or a compartment, when it is installed on the exterior of a Powersports vehicle, it's limitations are quickly realized.

There is no standard for this connector type allowing construction with different depths, and diameters. The male portion that plugs in makes up somewhat for this discrepancy by having a spring loaded positive and negative connection.

Even in the car, these connectors often vibrate out requiring the consumer to continually push them in to the socket to keep their device powered.

Most of these that are commercially available are only rated for around 3 amps with some of the best marine grade versions approaching 10amps.

These outlets are not waterproof nor are the male portions that plug in to them designed to be exposed to the elements.

SAE



SAE Connectors – These 2 pin connectors are commonly found on battery chargers. Many dealers install these to promote battery maintenance for the customer. While we offer many products that can utilize the SAE connectors to power multiple devices, there are some limitations you should be aware of.

Most of the supplied SAE harness do not have enough current capacity to allow the powering of high current devices such as heated clothing and tire inflater's. They are typically fused at 5 to 7.5 amps and can not be upgraded. The SAE harnesses and adapters that Powerlet sells are a true 15 Amp circuit.

To find what fits your specific bike visit:



GET WIRED, THEN GO PLAY™

powerlet.com

powerlet®
RUGGED ELECTRICAL ACCESSORIES

Powerlet Complete Solutions for Harley® Riders

Mid Kit Mounts

NEW!



Harley Mid Kit 1991 - Present
(Chrome Bracket)
PKT-026-C



Extruded Aluminum
Chrome Finish
Made in Detroit



Powerlet Socket Kit
PKT-042-24



To find what fits your specific bike visit:



www.[powerlet](http://www.powerlet.com)



Parts and Accessories for Harley® Motorcycles

GET IT ON

Handle Bar Mounts



Powerbar Plus Chrome
With Ram Ball
PKT-090-54-C



Powerbar Plus Chrome
With Ram Ball and Mount
PKT-090-54-C / Plus Mount

powerlet.com

powerlet®
RUGGED ELECTRICAL ACCESSORIES

Power Outlet Kits Complete Solutions

Horn Mount Charging kit

PKT-026-C *Harley Mid Kit Chrome*

PKT-026-B *Harley Mid Kit Black*



Patented Technology

For all 1991 and newer models with the horn bracket below the gas tank. High quality show chrome PKT-026-C or black PKT-026-B bracket with vibration proof Powerlet® socket.

True "Bolt-On" Installation with factory appearance.

While these kits take only 20 minutes to install, they provide years of use for battery charging, heated clothing, cell phone charging and more. The wiring harness lengths are also produced specifically for the vehicle.

Battery Charging (Power-In)

Heated Clothing

Luggage Electrix™

Electronic Devices

Lifetime Warranty



Stamped Aluminum
Chrome Finish
Made in Detroit

PKT-042-24 *Powerlet Socket Kit - 24" Harness*



Our second most popular panel kit, this 24 inch length works very well on metric Cruiser, Harley Davidson, and sport bike side panels. This kit works equally well on front panels for bikes with the battery in the front fairing.

Our most popular kit. Available in 12", 24", 36", 48", and 60" harness lengths. Requires you to drill a panel. 2" clearance required.

Parts and Accessories for Harley® motorcycles



Powerbar Plus™

*Billet Aluminum Construction
Chrome Finish
Made in Detroit*



Powerlet to USB Adapter



PAC-069 Dual USB Type A to Powerlet Adapter

The wait is over! Powerlet to Dual USB Adapter Charging Plug is the world's most powerful device charger for USB powered devices. This dual USB Powerlet plug charger packs colossal power into a modest frame. This Powerlet accessory allows you to charge 2 devices at once - even 2 iPads simultaneously. Each USB port has been designed to supply 25 Watts (2.1A) of power. PAC-069 ultra low-profile design fits into your Powerlet socket and is easily adapted into an Automotive socket with an AAC-001 (compatible metal insert). Ensuring the best use of valuable space on your motorcycle. Works with: iPad, iPod, iPhone, Android Devices, Smartphones, Tablets, BlackBerry and MP3 Players



Automotive / Powerlet Adapters Solutions

AAC-001



Plug a Powerlet into an automotive lighter socket. Since automotive sockets come in multiple variations, not all are compatible with this metal insert. If it does not work properly the AAC-003 will solve the problem.

AAC-003



Automotive socket to a Powerlet female. Warning: Most Automotive sockets are not rated to handle heated clothing. 12" Long.

AAC-006 USB Type A to Automotive Adapter



Convert a automotive socket to an USB Type A Connector. Input: 12 VDC to 30 VDC, Output: 5V at 2.1 Amp.

DPD-100-24 Dealer ONLY 24 Pack



PAC-050

Powerlet Power Pac™



This complete adapter set offers three of the most popular versions of adapters. Includes short versions of our Powerlet to Automotive adapter, Powerlet to SAE for battery charging and Powerlet to coax for heated clothing.

PAC-051

Powerlet Power Pac™



For customers not riding with heated clothing, this set offers an automotive socket to a USB Type A Connector. Input: 12 VDC to 30 VDC, Output: 5V at 2.1 Amp. Powerlet to SAE for battery charging and Powerlet to automotive adapter.

Parts and Accessories for Harley® motorcycles

www.powerlet

GET IT ON

Power Cables With Automotive Adapter.

PPC-036 iPhone 5



PPC-029 Mini USB



PPC-030 iPhone



PPC-031 Micro USB



Dented your tank with a automotive phone charger lately?

When utilizing the factory automotive socket on your Ultra or Street Glide, many have discovered that when the bars are turned to the left, your charger will dent the gas tank on all newer models with the 6 gallon tank. The above solutions utilize the factory socket but convert it to a vibration-proof Powerlet outlet. Using our power cables that use the low profile Powerlet plug, your device can be powered without fear of denting your tank.

The above parts utilize the AAC-001 Automotive to Powerlet adapter along with a short-ened version of our most popular device specific charging cables featuring a 18" cable length.

Powerlet Complete Solutions for BMW® Riders

Mid Kit Mounts

ICAN-Left Side Under Seat
Socket Kit-12"
PKT-042



Powerlet Socket Rear Set Kit
PKT-043



Powerlet Socket Kit 48" harness
PKT-042-48

Powerlet to USB Adapter

NEW!

PAC-069 Powerlet to Dual USB
Adapter Charging Plug.

This Powerlet accessory allows you to
charge 2 devices at once - even 2
iPads simultaneously. Each USB port
has been designed to supply 25 Watts
(2.1A) of power.



Powerlet Socket Kit 48" harness
With Power Cord Accessory

To find what fits your specific bike visit:



www.powerlet.com/show-by-vehicle

www.powerlet



Handle Bar Mounts



Powerbar Plus 1-1/8" To 1-1/4" Black Anodized
PKT-091-54-B



Powerbar Plus 7/8" To 1" Black Anodized
PKT-090-54-B With Mounting Kits

Parts and Accessories for BMW[®] Motorcycles

.com

Power Outlet Kits

BMW[®] Motorcycles / BMW[®] CANbus[®]

HEATED CLOTHING
iCAN[™]
BMW CANBUS
BATTERY CHARGING

When CANbus can't, Powerlet CAN

Now you can safely power your heated clothing or use your standard battery charger on your 2005 and later CANbus equipped BMW motorcycle using our simple iCAN Harness. Don't be tempted to dangle cheesy cords off your bike when you can have a proper factory looking outlet. Visit your local participating BMW GWIP program dealer for a new bike that is already Powerlet Equipped!

PKT-042 Standard iCAN Kit

This kit replaces the factory 5 amp CANbus outlet allowing the use of standard battery chargers and heated clothing by converting it to a true 15 amp outlet. Available in 12", 36" & 48" harness lengths.



PKT-046 Low Profile iCAN Kit

Some BMW applications will call for a low profile iCAN kit depending on clearance behind the socket. Consult our Shop by Vehicle section of our website for specific kit fitment.

BMW[®] 5 amp
Outlet

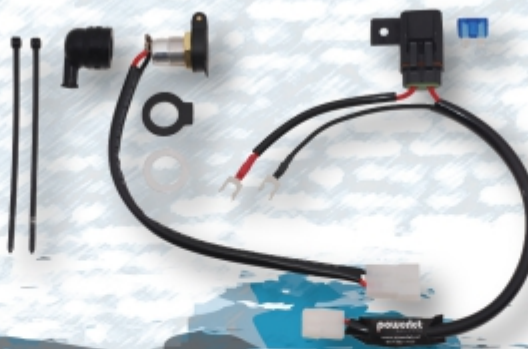

www.[powerlet](http://www.powerlet.com)



The CANbus Problem

Factory BMW outlets powered by the CANbus system turn on and off with the motorcycle ignition, which does not allow the use of a standard battery charger. CANbus-driven outlets also automatically shut off when the current exceeds 5 amps; prohibiting the use of most heated clothing, which can draw up to 15 amps. BMW's current outlets are only rated for 5 amps.

Powerlet Solution

Powerlet's iCAN solutions provides a true 15 amp outlet heavy duty replacement wiring harness allowing the use of a standard battery charger and heated clothing. The replacement harness will not affect or damage the CANbus system.



Powerlet Complete Solutions for Cruiser Riders
Mid Kit Mounts

Automotive Socket Battery Lead
(Standard Duty 10 Amp 48") PKT-101-48



Powerlet Socket Kit PKT-042-24



www.powerlet.com



Handle Bar Mounts

Powerbar Plus 7/8" To 1" Chrome
PKT-090-54-C



Powerbar Plus 1-1/8" To 1-1/4" Chrome
PKT-091-54-C

Parts and Accessories for Cruiser Motorcycles

.com

powerlet[®]
RUGGED ELECTRICAL ACCESSORIES

Powerlet Complete Solutions for Touring/Sport Touring Riders

Front Panel Mounts



Left Front Panel Kit PKT-042-48



Mid Kit Mounts



Powerlet Socket Kit PKT-042-24





ies for Touring / Sport Touring Motorcycles

.com



Luggage Electrix



Luggage Electrix Tankbag & Saddlebag
Power Kit PTB-004



powerlet®
RUGGED ELECTRICAL ACCESSORIES

Powerlet Complete Solutions for Adventure Riders

Powerlet to USB Adapter

NEW!

PAC-069 Powerlet to Dual USB Adapter Charging Plug.

This Powerlet accessory allows you to charge 2 devices at once - even 2 iPads simultaneously. Each USB port has been designed to supply 25 Watts (2.1A) of power.

Mid Kit Mounts

Powerlet Side Panel Kit 24" harness
PKT-042-24



Powerlet Type-3 Rearset Kit
PKT-069-B



Powerlet Type 2 Rearset Kit
PKT-043
Also available in Type-1 Rearset.
PKT-041

Front Panel Mounts

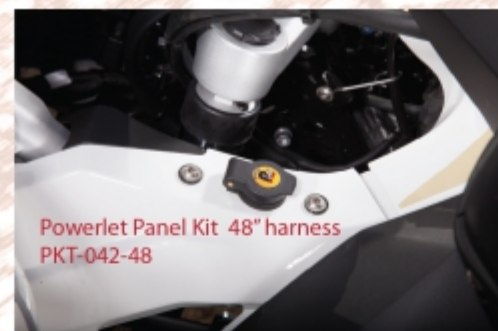

Powerlet Panel Kit 48" harness
PKT-042-48



To find what fits your specific bike visit:



www.powerlet



Luggage Electrix Tankbag & Saddlebag
Power Kit PTB-004



Handle Bar Mounts



Powerbar Plus 1-1/8" To 1-1/4" Black Anodized
PKT-091-54-B



Powerbar Plus 7/8" To 1" Black Anodized
PKT-090-54-B With Mounting Kits

Parts and Accessories for Adventure Motorcycles

.com

powerlet[®]
RUGGED ELECTRICAL ACCESSORIES

Powerlet Complete Solutions for Off Road Riders

Panel Mount Kits

Powerlet Socket Kit 48" harness
PKT-042-48



Mid Kit Mounts



Type-1 Rerset Kits
PKT-041-B

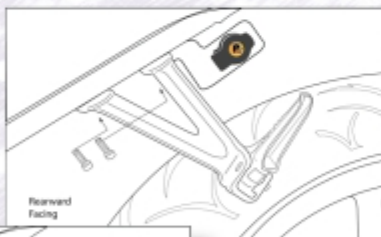

Type-3 Rerset Kit
PKT-069-B

Also available in Rerset Type-2
PKT-043



[www.powerlet](http://www.powerlet.com)



Handle Bar Mounts



Powerbar Plus 1-1/8" To 1-1/4" Black Anodized
PKT-091-54-B



Powerbar Plus 7/8" To 1" Black Anodized
PKT-090-54-B with mount kits.

Parts and Accessories for Off Road Motorcycles

.com

powerlet[®]
RUGGED ELECTRICAL ACCESSORIES

Powerlet Complete Solutions for Sport Bike Riders

Mid Kit Mounts



Powerlet Socket Kit 48" harness
PKT-042-48



Cell Phone



USB

Powerlet EZ Power Kit
PKT-101-48





Parts and Accessories for Sport Bike Motorcycles

powerlet.com



Mid Kit Mounts



Type-1 Rearset Kit (Black)
PKT-041-B



Type-3 Rearset Kit
PKT-069-B
Also available in Type-2 Rearset Kits
PKT-043-B

powerlet[®]
RUGGED ELECTRICAL ACCESSORIES

Power Outlet Kits

Powerlet Powerbar Plus

Powerlet's Power Bar Plus permits riders to mount and power their device off the same bracket. Made right here in Detroit, the Powerbar Plus is a billet aluminum bracket that is finished in either a chrome or black anodized finish. This complete kit comes with a 60" harness and everything you need for an easy install. Included rubber dampers add an additional level of vibration damping for your device. Most commonly used to mount and power cell phones, GPS, and radar detectors. With our quick release mounting systems, you have the ability to quickly remove your device and power cords when you have finished your ride. As with all Powerlet outlets, you can power out to power your devices and keep your battery charged.

PKT-090-54-C

PKT-090-54-B

Fits 7/8" To 1" sized handlebars most commonly used on Cruisers and Harleys. Available in black anodized or chrome.



PKT-091-54-C

PKT-091-54-B

Fits 1-1/8" To 1-1/4" sized handlebars commonly found on Adventure and Off Road type motorcycles. Available in black anodized or chrome.



Powerbar Plus™



To find what fits your specific bike visit:



www.powerlet.com/shop-by-vehicle

www.powerlet



Power Outlet Kits



.com

powerlet[®]
RUGGED ELECTRICAL ACCESSORIES

Power Outlet Kits

Automotive Powerbar

Powerlet's Automotive Powerbar permits riders to power out to their device and also charge the vehicles battery using Automotive based charging cords. The Powerbar also includes a lighter element for you smokers out there. This complete kit comes with everything you need for an easy install. Combine with our AAC-002 to allow easy battery charging or our AAC-006 to power a USB based device. Made right here in Detroit, this high quality solution has a 10 amp capacity.



AKT-003-60-C

Fits 7/8" To 1" sized handlebars commonly found on most cruisers and Harleys.



AKT-004-60-C

Fits 1-1/8" To 1-1/4" sized handlebars used in many custom applications. Available for custom orders only.



Power Outlet Kits **GET IT ON**

.com

powerlet[®]
RUGGED ELECTRICAL ACCESSORIES

Bracket Mounted Kits



Easy
Install



[www.powerlet](http://www.powerlet.com)

Rearset Mounted Kits

Powerlet's Rearset Kits are designed to fit the most common sub-frames using rearset mounts with three different versions. The harness lengths are optimized for batteries that are located under the seat. These kits offer a simple bolt on solution most commonly used to charge cell phones, power heated clothing, battery charging, and tire inflators. These kits take only 20 minutes to install, and come complete with everything you need to do the job. Made right here in Detroit with an OEM appearance, you can forget dangling ugly cables out under your seat.



PKT-041-B Type 1 Rearset Kit

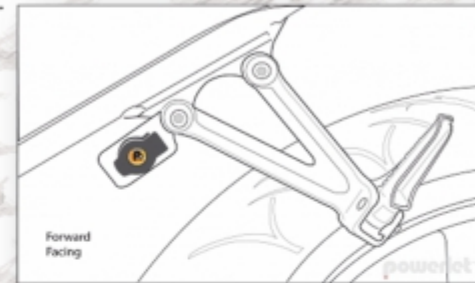

PKT-043 Type 2 Rearset Kit

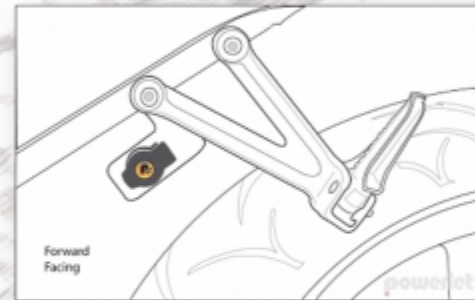

PKT-069-B Type 3 Rearset Kit



Cable Mounted Powerlet Outlets

Cable-mounted Powerlet sockets are designed for ease of installation. Ideal for those not wanting to drill into a panel.

PKT-003 Powerlet Socket Battery Harness

Quickly install a Powerlet 15 amp outlet anywhere on your vehicle. Kit comes complete with everything needed for an easy install and also includes a C-clip to retain the outlet and a weather proof cap.



Cable Mount Automotive Outlets

PKT-101 EZ Power Kit

Quickly install an Automotive socket anywhere on any vehicle. Features a heavy duty 15 amp battery to SAE lead, and SAE to Automotive outlet adapter allowing battery charging, and cell phone or GPS powering. The SAE to Automotive adapter can be stored when not in use. Also comes with a weather proof cap for the outlet and a C-clip to secure it.

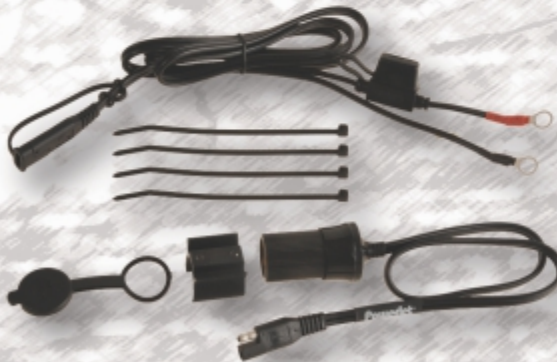

PKT-101 EZ Power Kit



Panel Mount Outlets

As with all Powerlet socket kits, these power outlets can do everything. Power-in for battery charging, no problem. 15 amps out for heated gear, no problem. The fuse-holders are waterproof and use standard ATO style fuses. The terminals are highly annealed copper. Heavy duty wiring harness made from UV stable, oil and gas resistant components. 105C 16 AWG wire and sleeving. With a variety of harness length options, you can put your outlet where ever you need it. Factory installed appearance and easy installation.

Power Outlet Kits



PKT-042 Powerlet Socket Kit

Our most popular kit. Available in 12", 24", 36", 48", and 60" harness lengths. Requires you to drill a panel. [2" clearance required behind panel to mount.]



PKT-046 Low Profile Powerlet Socket Kit

Low profile socket reduces depth needed behind the panel. Available in a variety of harness lengths that include 12", 24", 36", 48" and 60". [Requires 1" behind panel to mount.]



PKT-039-12 Multi-Fit Second Socket Kit (12")

Adds a second Powerlet socket without adding a second harness. Plugs into any Powerlet harness with a white T-connector.



Automotive Panel Mount Outlets



AKT-001 Automotive Socket Panel Mount Kit

Weather-proof tether lid. T-connector makes wiring easy. This high quality socket requires a 1.125" hole. Top flange is 1.510" diameter & requires 1.75" behind the panel. Comes with a cigarette lighter element. 10 amp capacity.

Termin 8

Powerlet Specialty Kits

Powerlet's Specialty Kits are designed for the farkers and adventurers out there. From just managing connections for all your accessories to allowing easy jumping of your battery, Powerlet has you covered.



NEW!

PKT-103 Termin-8

Have a bunch of accessories you want to hook up but don't have room on your battery? Termin-8 makes it easy to mount up to 8 devices with only one connection at the battery post. No more worrying about where to mount a chunky fuse block. Made with heavy duty 12 AWG wire, hard coat anodized with red and black color blocks for easy installation. Termin 8 is capable of handling 20 amps. This solution also makes it easy to service your devices by simply pulling the fuse. Patented.



www.powerlet.com



Real Jumper Cables

Take the worry out of jump starting motorcycles and ATV's with this high current jumper cable kit. This kit provides a convenient method for group leaders to jump start another members vehicle or their own vehicle. A favorite product for adventure touring riders that travel to remote parts of the world. Used by police and military personnel. Standard harness length is 60 inches, short enough to store and long enough to reach from one vehicle to another. Our jumpstart kits are assembled and tested in the USA by people who ride. Made with flexible marine grade 8 awg solid copper wire that is oil and gas resistant and UV stable. Fully annealed terminals and the highest current connector available ensures maximum power transfer. Quality components and attention to detail ensure Powerlet products resist wear and corrosion to last a lifetime.

PKT-104

Made of the highest quality components, this product can deliver the power from one vehicle to another. Designed to be small in size and easy to pack on your bike or ATV.



easy install



easy connect



powerlet
EQUIPMENT
www.powerlet.com
877-752-7033
Made in USA

.com

Universal Power Kits

When you need a low cost, quick installation of a 12V power outlet, look no further. Powerlet offers these easy to install kits designed to provide you with either a SAE, Powerlet, Coax, or Automotive outlet. For quick powering of heated clothing, battery charging, or just charging your cell phone.

Made from the highest quality materials, all components are UV stable and are oil/gas resistant and will not deteriorate over time. The fuse-holders are waterproof and use standard ATO style fuses. The terminals are highly annealed copper. Everything you need is included right down to the tie-wraps.



PKT-001 Heavy Duty SAE Battery Lead

Our heavy-duty SAE battery leads can handle 15 amps of current. Other SAE battery leads use much thinner wire and are fused at 3 to 7.5 amps not allowing the powering of high current devices such as tire inflators or heated clothing. Includes a 15 amp fuse and tethered dust cap. Available in 24" or 48" harness lengths.



PKT-003 Powerlet Socket Battery Harness

Heavy duty wiring harness made from UV stable, oil and gas resistant components. 105C 16 AWG wire and sleeving. Cable mounted Powerlet socket with a 15 Amp capacity. 48" Harness with weatherproof cap and C-clip for easy mounting.

Universal Power Kits

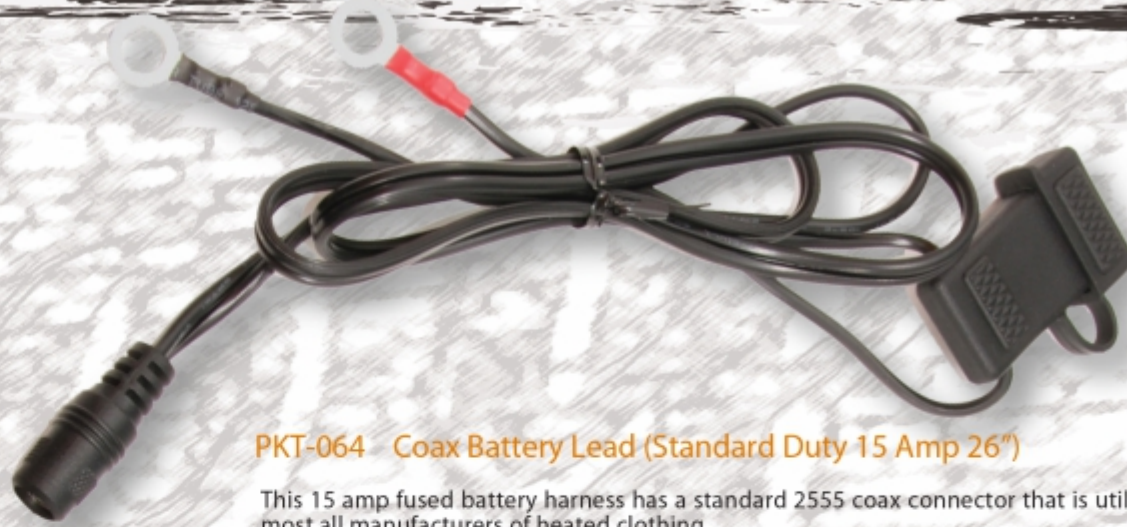

PKT-064 Coax Battery Lead (Standard Duty 15 Amp 26")

This 15 amp fused battery harness has a standard 2555 coax connector that is utilized by most all manufacturers of heated clothing.

Fit's ALL Motorcycles
Makes and Models.
Easy Power Solution.



PKT-101 EZ Power Kit

Quickly install an automotive socket on any vehicle. The socket is secured with provided C-Clip and comes with a weather proof cap. SAE to Automotive adapter cable can be removed for easy storage. Fused at 15 amps and designed for an easy install, this is our most popular simple solution for cell phone or GPS charging while also allowing you easy access to charge your vehicles battery.

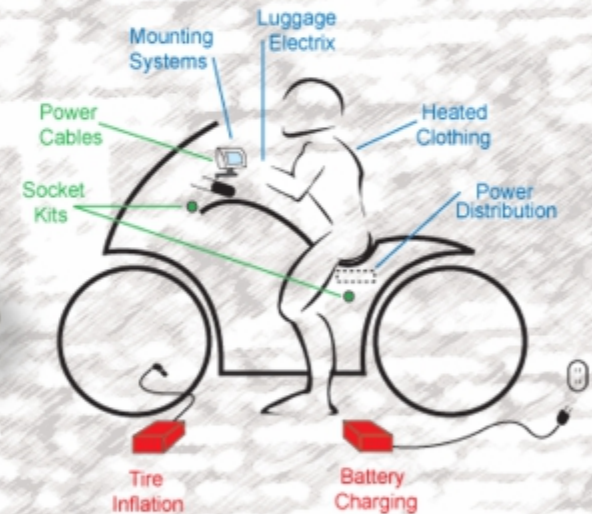

USB Powerlet® Adapter



PAC-069 Dual USB Type A to Powerlet® Adapter

The wait is over! Powerlet® to Dual USB Adapter Charging Plug is the world's most powerful device charger for USB powered devices. This dual USB Powerlet® plug charger packs colossal power into a modest frame. This Powerlet® accessory allows you to charge 2 devices at once - even 2 tablets simultaneously. Each USB port has been designed to supply 25 Watts (2.1A) of power. PAC-069 ultra low-profile design fits into your Powerlet® socket and is easily adapted into an automotive socket with an AAC-001 (compatible metal insert). Ensuring the best use of valuable space on your motorcycle. Works with: iPad, iPod, iPhone, Android Devices, Smartphones, Tablets, BlackBerry and MP3 Players



RUGGED ELECTRICAL ACCESSORIES



GEI
ITA



.com

powerlet®
RUGGED ELECTRICAL ACCESSORIES

Power Cables

Powerlet® offers the most complete line of power and adapter cables for the powersports industry. Powering a cell phone, GPS, iPod®, or radar detector is simple with our cables. Cell phones use more power trying to seek towers during travel causing the battery to die early in the day. This is not a problem when you are Powerlet® Equipped. Battery charging through your Powerlet® socket is also easy with cables designed to both power out and power in. Battery chargers typically double the useful life of AGM, wet or sealed batteries. Using a charger means a greener planet.

Complete Adapter Sets



PAC-050

Powerlet® Power Pac™

Powerlet® offers this combination pack of three of the most popular versions of cables used with Powerlet® sockets. This item includes short versions of our Powerlet® to automotive socket for cell and GPS charging, Powerlet® to SAE for battery charging and Powerlet® to coax for heated clothing.

PAC-051

Powerlet® Power Pac™



For riders not using heated clothing (who are you?), This item includes our AAC-006 adapter that fits in to the Powerlet® to automotive socket allowing the powering of any USB based device; 12 VDC to 30 VDC, Output: 5V at 2.1 Amp. Also includes Powerlet® to SAE for battery charging and Powerlet® to automotive for cell phone and GPS charging.



PPC-060 Extension Cable USB TO USB

USB Extension Cable 12" length. Works with all USB Cords to give you that extra length to connect conveniently with other devices.

Power Cables and USB Adapter Cables



www.powerlet



NEW PAC-061 Adapter Cable USB TO MINI USB

Works with most devices that utilize a mini USB connector. Short cable 6.5 inches to work conveniently with Powerbar and Powerbar Plus. Includes PPC-024 required for use with Garmin GPS units. Special circuitry inside this adapter puts the GPS in charge mode.

NEW PAC-062 Adapter Cable USB TO MICRO USB

Works with most devices that utilize a Micro USB connector. Short cable 6.5 inches to work conveniently with Powerbar and Powerbar Plus.

NEW PAC-063-USB Adapter Cable USB TO iPhone®

Works with Apple® iPhone® 3G, 3GS, 4G, 4GS, and iPod® Touch. Short Cable 6.5 inches to USB to work conveniently with Powerbar and Powerbar Plus.

NEW PAC-064 Adapter Cable USB TO iPhone® 5

Works with NEW Apple® iPhone® 5. Short Cable to USB 6.5 inches to work conveniently with Powerbar and Powerbar Plus.

NEW PAC-065 Adapter Micro USB TO iPhone® 5

Adapter for easy connection to iPhone® 5 from a Micro USB Adapter

NEW PAC-066 Adapter iPhone® TO iPhone® 5

iPhone® 5 adapter accessory works with Apple® iPhone® 3G, 3GS, 4G, 4GS, and iPod® Touch power cords to adapt to iPhone® 5.



Power Cables

Automotive Adapter Choices

Converts from an automotive type socket to power any device.



AAC-006

Convert an automotive socket to a USB Type A Connector. Input: 12 VDC to 30 VDC, Output: 5V at 2.1 Amp.



DPD-100-24

Dealer Only



AAC-003

Converts an automotive socket to a Powerlet® female. Warning: most automotive sockets are not rated to power high current devices such as heated clothing. 12" Long.



AAC-002

Plug a battery charger into an automotive socket. Warning: automotive outlets are not rated to handle high current devices such as tire inflators. Some are switched with the ignition not allowing battery charging. 9" Long.



AAC-001

Plug a Powerlet® plug into an automotive socket. Since automotive sockets come in multiple variations, not all cigarette sockets are compatible with this metal insert. If it does not work properly the AAC-003 will solve the problem.

Powerlet® Adapter Choices

Converts any Powerlet® type socket to an automotive socket



PAC-002

Converts any Powerlet® type socket to an automotive socket. 10" cable length.



PAC-012

Using Powerlet®'s right angle plug for low profile applications, this adapter converts any Powerlet® type socket to an automotive socket. 24" in length.



PAC-043

One piece rigid Powerlet® plug to automotive socket adapter.



PAC-028

Connect two automotive plugs to a Powerlet® socket. Approximately 10" and 12" long cable leads.



PAC-029

Convert a Powerlet® socket to both an automotive socket and Powerlet® socket. 8" and 10" staggered length.



PAC-036

Powerlet® low profile plug to two automotive sockets. Approximately 60" long.



PAC-031

Connects any two devices that have an automotive type plug to a Powerlet® socket. Coil cord is 24" then stretches to over 4 ft. for easy connection.



Power Cables / Cell Phone Charging Cables



New iPod® 5 Cable Choices

PPC-033 iPod® 5



Works with iPod® iPod® 5 and iPod® Touch. Features voltage reduction circuitry in a 32" coil cable with Powerlet® right angle plug.

PPC-033-SC iPod® 5



Works with iPod® iPod® 5 and iPod® Touch. 12" overall length with Powerlet® plug is perfect for using with Powerbar Plus or just when you don't need a long cable.

PPC-033-DB iPod® 5



Works with iPod® iPod® 5 and iPod® Touch. With a 60" cable length, this cable is designed to connect directly to the vehicle's battery.

PPC-036 iPod® 5

Automotive to Powerlet® Solution



iPod® 5 and iPod® Touch solution includes automotive to Powerlet® insert (AAC-001) and the Powerlet® PPC-033 iPod® 5 cable. 18" Length coil cable with Powerlet® right angle plug. Perfect Solution to maximize the factory Harley fairing mount socket without clearance issues.

iPod® & iPhone® 3, 4 and 4S Cable Choices

PPC-026 iPod® & iPhone® 3, 4 and 4S



Works with iPod® iPod® 3G, 3GS, 4G, 4GS, iPads and iPod® Touch. Features voltage reduction circuitry in a 32" cable length with Powerlet® right angle plug.

PPC-026-SC iPod® & iPhone® 3, 4 and 4S



Works with iPod® iPod® 3G, 3GS, 4G, 4GS, iPads and iPod® Touch. 12" Long with Powerlet® plug, this short cable is optimized for use with our Powerbar Plus.

PPC-026-DB iPod® & iPhone® 3, 4 and 4S



Works with iPod® iPod® 3G, 3GS, 4G, 4GS, iPads and iPod® Touch. With a 60" cable length, this cable is designed to connect directly to the vehicle's battery.

PPC-030 iPod® & iPhone® 3, 4 and 4S

Automotive to Powerlet® Solution



Works with iPod® 3G, 3GS, 4G, and 4GS, iPads and iPod® Touch. Solution includes automotive to Powerlet® insert (AAC-001) and the Powerlet® PPC-026 cable. 18" Length coil cable with Powerlet® right angle plug. Perfect Solution to maximize the factory Harley® automotive fairing mounted socket without clearance issues. fairing mount socket.

Micro USB Cable Choices

PPC-027 Micro USB

Works with all Android, Blackberry and any device requiring a Micro-USB. Features voltage reduction circuitry in a 32" cable length with Powerlet® right angle plug.



PPC-027-SC Micro USB

A short cable version of the Micro-USB cable. This short cable length measures approximately 12 inches and is ideal for situations that may require a little less cable.

PPC-027-DB Micro USB

A direct to battery harness version of the Micro-USB cable designed to work with all devices using this connector type. 60" overall length designed to connect directly to the vehicle's battery.



PPC-031 Micro USB

Micro USB solution includes automotive to Powerlet® adapter (AAC-001) and the Powerlet® PPC-027 Micro USB cable. 18" length cable with Powerlet® right angle plug. Perfect Solution to maximize the factory Harley® fairing mount socket without

Automotive to Powerlet® Solution



Mini USB and GPS Cable Choices

PPC-015 Mini USB and GPS

Works with most appliances that utilize a Mini USB connector. Features voltage reduction circuitry in a 32" cable length with Powerlet® right angle plug. Includes PPC-024 adapter for Garmin GPS units.



PPC-015-SC Mini USB and GPS

Works with most devices that utilize a Mini USB connector. 12" length with a Powerlet® straight plug. Includes PPC-024 adapter for Garmin GPS units.

PPC-015-DB Mini USB and GPS

Works with most appliances that utilize a Mini USB connector. Direct to battery 60" fused harness. Includes PPC-024 adapter for Garmin GPS units.



PPC-029 Mini USB and GPS

Mini USB solution includes automotive to Powerlet® adapter (AAC-001) and the Powerlet® PPC-015 Mini USB cable. 18" cable with Powerlet® right angle plug. Includes PPC-024 adapter. Perfect Solution to maximize the factory Harley® fairing mount socket without clearance issues.

Automotive to Powerlet® Solution



Power Cables

Garmin Cable Choices



PPC-015

Works with most devices that utilize a Mini USB connector. Features voltage reduction circuitry in a 32" coil cable with Powerlet® right angle plug. 32" coil cable length and Powerlet® right angle Plug. Includes PPC-024 adapter for Garmin GPS units.

PPC-024

This adapter is included in all our PPC-015 cables. Required for use with Garmin GPS units. Special circuitry inside this adapter puts the GPS in charge mode.





Radar Detector Cable Choices

Powerlet® supports a variety of different cables for various radar detector manufactures. Available in 36" lengths, 12" SC short cable, and DB direct to battery configurations.



PPC-004

Works with Escort, Valentine 1, Beltronics RX65 and a number of other compatible radar detectors using a RJ11 jack. 36" Coil cable and Powerlet® right angle Plug.



PPC-004-DB

Works with Escort, Valentine 1, Beltronics RX65 and a number of other compatible radar detectors using a RJ11 jack. Direct to battery 60" fused harness.

Power and Mount A Gadget

With most everyone using smart phones and GPS devices these days, Powerlet's mounting systems are the perfect partner with our Powerbar Plus (sold separately) to allow you to both mount and power your device right off your handlebars. If you want to stream music, talk on the phone, navigate, or text your riding buddy (none of these are recommended of course) Powerlet has you covered.

NEW!

PBK-023

Cradle and power your Android, Blackberry or any device requiring a Micro-USB. This kit provides RAM components to mount the phone from a Powerlet® Powerbar Plus (sold separately). PAC-069 DUAL USB Type A to Powerlet® Charger with short USB To Micro USB Power Cable 6.5" Length. PAC-062-USB



NEW!





Mounting Systems



PBK-024

Cradle and power your Apple iPhone 3G, 3GS, iPhone 4 and 4S. This kit provides RAM components to mount the phone from a Powerlet® Powerbar Plus (sold separately). PAC-069 DUAL USB Type A to Powerlet® Charger with short USB To iPhone 3G, 3GS, 4 and 4S USB Power Cable 6.5" Length. PAC-063-USB cable powers the iPhone without excess cable.



PBK-025

Cradle and power your Apple iPhone 5. This kit provides RAM components to mount the phone from a Powerlet® Powerbar Plus (sold separately). PAC-069 DUAL USB Type A to Powerlet® Charger with short USB To iPhone 5 USB Power Cable 6.5" Length. PAC-064-USB cable powers the iPhone 5 without excess cable.

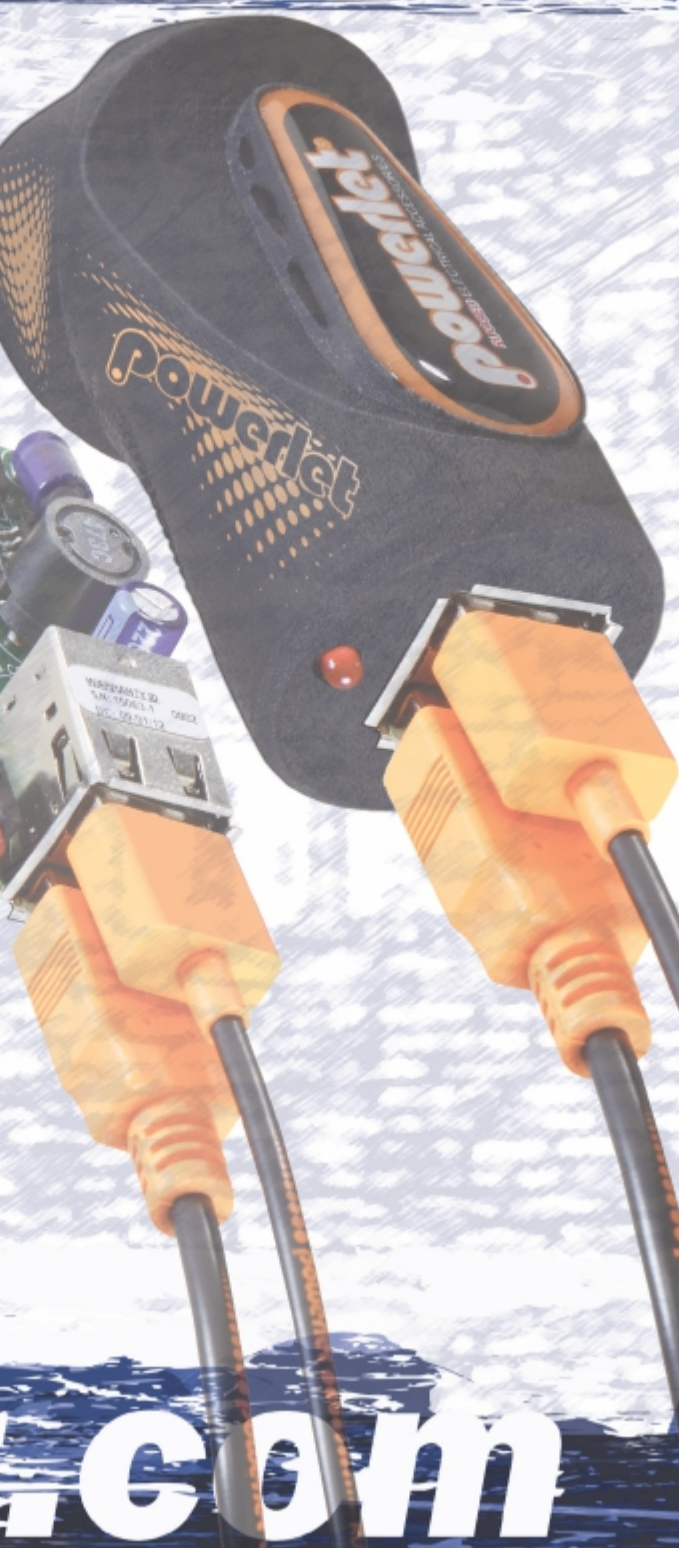

Power and Mount a Gadget



PBK-007

RAM Double Socket Arm For 1" Ball

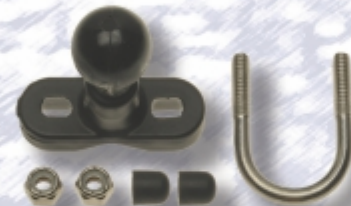

PBK-008

RAM Base w/ U-Bolt Fits 3/4" To 1 1/4" Diameters



PBK-009

RAM 2 7/16" X 1 5/16" Diamond Base w/ 1" Ball



PBK-010

Used with our Powerbar Plus series. 3/8"-16 thread pitch.

PBK-012



Cradle and power your Apple iPhone 3G, 3GS, iPhone 4 and 4S. This kit provides RAM components to mount the phone from a Powerlet® Powerbar Plus (sold separately). Included short Powerlet cable powers the iPhone without excess cable.

PBK-015



Cradle Apple iPhone, with this rugged universal cradle. Does not come with PBK-009 Ram ball diamond Base. This cradle is used in our PBK-012 and PBK-013 Mounting Kits. Adjustable to work with phone bumper / case / skin.

PBK-020

Cradle and power your Apple iPhone 5, and any Apple device with a Lightning® connector. This kit provides RAM components to mount the phone from a Powerlet® Powerbar Plus (sold separately). Included short Powerlet cable powers the iPhone without excess cable.



PBK-013



Cradle and power your Droid, Blackberry and other devices. This kit provides RAM components to mount the phone from a Powerlet® Powerbar Plus (sold separately). Included short Powerlet cable powers phone without excess cable using the Micro USB connector.

PBK-017



RAM Motorcycle perch mounted brake/clutch reservoir base with 1" Ball.



Plugs, Sockets, Wiring & More

Powerlet® Plug Choices

NEW

PPL-006 Straight Plug

New and Improved straight Powerlet® Plug. Features improved construction for easy installation with flat spade connector and straight barrel crimp. Good for heated vest cords, radar detector cables, GPS units, - the stuff you use while riding (includes new re-designed strain relief). NOTE: When replacing an existing automotive plug, verify that the automotive plug does not contain a voltage reduction circuit.



NEW

PPL-007 Right Angle Plug

New and improved right angle Powerlet® plug. Features improved construction for easy installation with flat spade connector and straight barrel crimp. Low profile plug. (new re-designed strain relief). NOTE: When replacing an existing automotive plug, verify that the automotive plug does not contain a voltage reduction circuit.



PPL-002 Deluxe Plug

Good for radar detectors, GPS Units, cell phone adapter cables - the stuff you bring riding. Includes a cable clamp (strain relief) & grommet. NOTE: When replacing an existing automotive plug, verify that the automotive plug does not contain a voltage reduction circuit.



PPL-003 Super Duper Plug

Good for heated vest cords, radar detector cables, GPS units, - the stuff you use while riding (includes strain relief & boot). NOTE: When replacing an existing automotive plug, verify that the automotive plug does not contain a voltage reduction circuit.



PPL-004 Right Angle Plug

Low profile plug. NOTE: When replacing an existing automotive plug, verify that the automotive plug does not contain a voltage reduction circuit.



Plugs, Sockets, Wiring & More

Powerlet® Socket Choices

PSO-001
Standard Outlet

Our most popular socket with spring-loaded hinged lid. Two 1/4" spade connectors, make wiring easy. 18mm brass jam nut. Rated at 15 amps, snap-fit and vibration proof. Requires .6875" (11/16") hole and 2.00" behind the panel. Lid measures 1.075" in diameter.

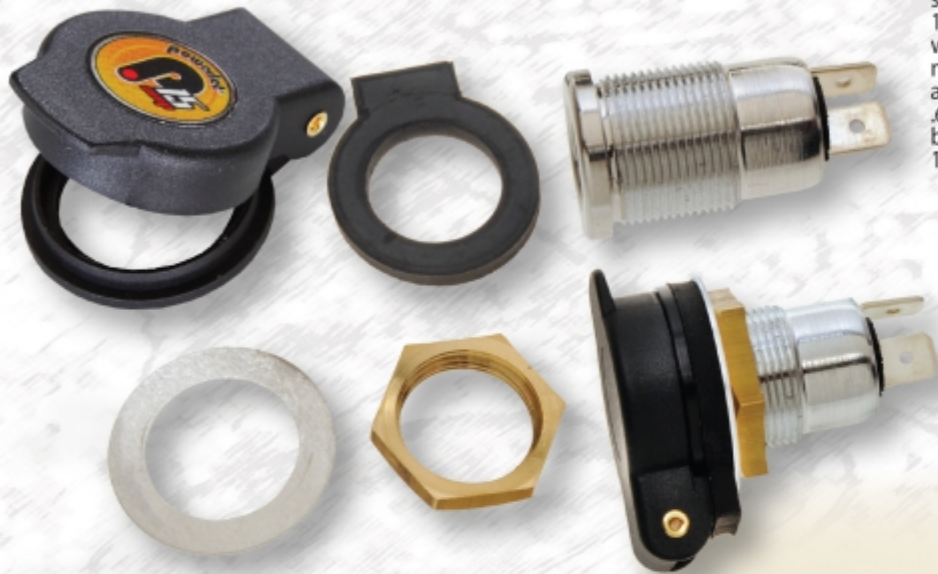

PSO-004
Cable Mounted Powerlet® Socket

Use this socket to make custom extension cables. Two internal spade lugs are provided for easy connection. Unlike automotive sockets these Powersport Standard Connectors are smaller in size, rated at 15 amps and are vibration proof.



www-powerlet



PSO-007
Low-Profile Powerlet® Outlet

Spring-loaded hinged lid. White-T connector uses 1/4" spade connectors on 9.00" leads. 18mm brass jam nut mounting. Rated at 15 amps, snap-fit and vibration proof. Requires .6875" (11/16") 18mm hole and 1.00" behind the panel. Lid measures 1.075" in diameter.



PSO-008
Powerlet® Socket Complete

Now a complete socket solution. Includes our most popular socket PSO-001 with rubber boot, white T connector, and terminals to simplify wiring. 18mm ss jam nut. Rated at 15 amps, snap-fit and vibration proof. Requires .6875" (11/16") 18mm hole and 2.00" behind the panel. Lid measures 1.075" in diameter.

Individual Automotive Sockets



ASO-002 Panel Mount
Automotive-Socket

Marine grade with rubber / weather-resistant tethered lid. Socket mounts through panel with jam nut for fastening. Rated to run most all appliances. Requires 1.125" hole and 1.75" behind the panel. Top panel flange measures 1.510" in diameter. White-T Connector lead for easy wiring.

Plugs, Sockets, Wiring & More

Fuse Blocks

PKT-103 Termin-8



Have a bunch of accessories you want to hook up but don't have room on your battery? Termin-8 makes it easy to mount up to 8 devices with only one connection at the battery post. No more worrying about where to mount a chunky fuse block. Made with heavy duty 12 AWG wire, hard coat anodized with red and black color blocks for easy installation. Termin-8 is capable of handling 20 amps. This solution also makes it easy to service your devices by simply just pulling the fuse. Patented.

PMI-001 Water proof Fuse Holder



Holds 1 ATO fuse, 1 amp to 15 amp.

PMI-002 4 Position Fuse Holder



Holds 4 ATO fuses, 1 amp to 15 amp.

Ground Blocks

PMI-017 Ground Block

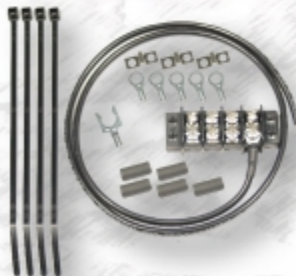

Convenient grounding block assembly accommodates ground wire connections. Small size enables installation anywhere on the bike. Comes with block, jumpers, crimp connectors and UV stabilized straps.

PMI-019 Fuse Block Assembly



Holds 4 ATO fuses, 3 amp to 15 amp. Kit comes complete with PMI-002 Fuse block, jumping wires, crimp connectors, battery lead and UV stabilized black straps.



Look Familiar? What a Mess.

Let Powerlet® help you organize the wires under your seat, safely and securely. You have nothing to lose but the mess. We have a variety of options and solution, that won't break the bank.

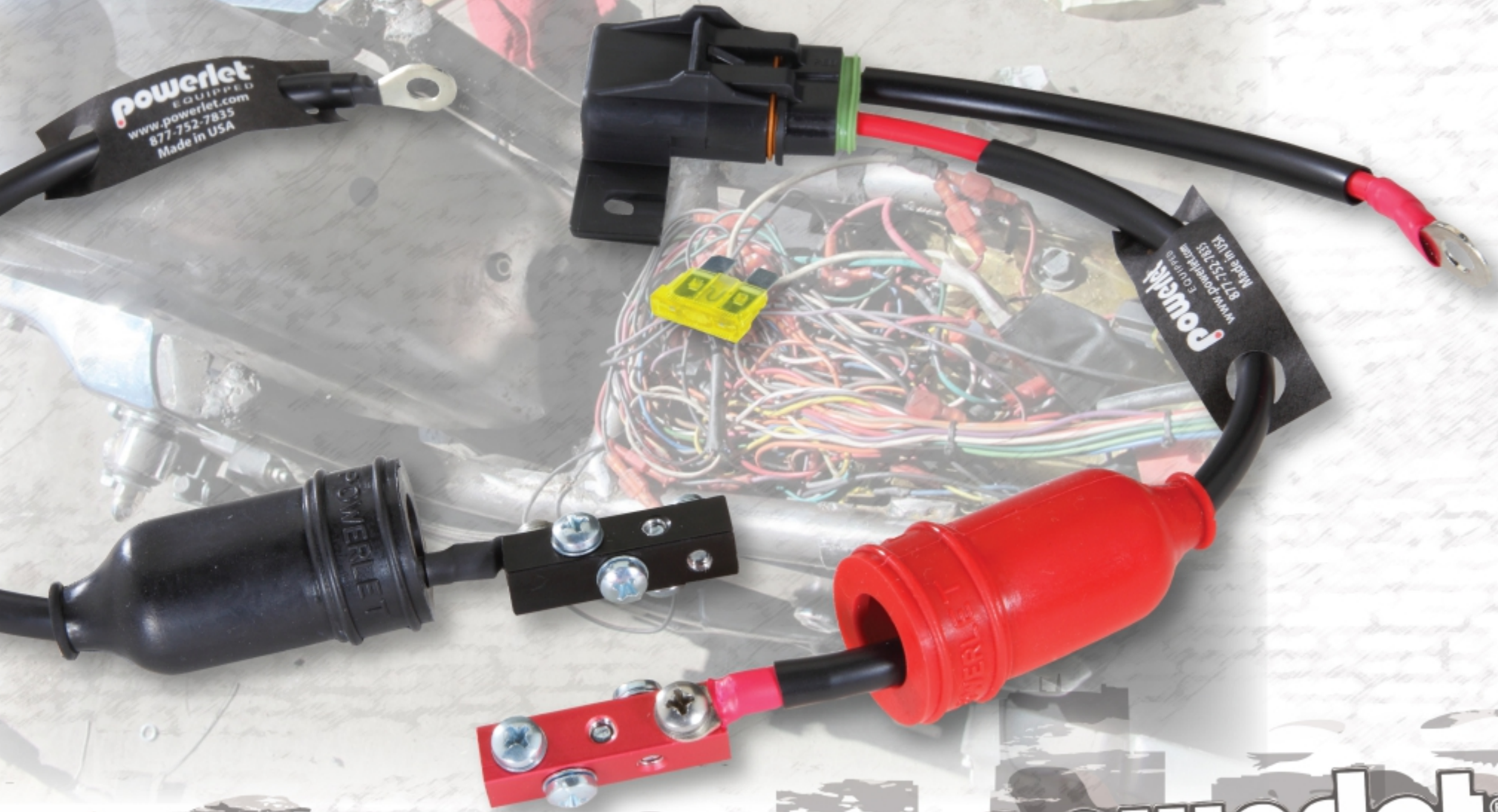

powerlet.com

powerlet®
RUGGED ELECTRICAL ACCESSORIES

Plugs, Sockets, Wiring & More

Automotive Socket Accessories

PMI-004 Automotive Socket C-Clip



With two screw mount holes this clip provides a convenient way to hold the cable mounted Automotive socket.

PMI-003 Automotive Socket Cover



The rubber cap fits our standard Automotive socket, providing protection from the elements when not in use.

Powerlet® Socket Accessories

PMI-005 Powerlet® C-Clip (For PSO-004)



Mountable with a single screw. This clip provides a convenient way to hold a cable mount Powerlet® socket. Holds the socket when not in use.

PMI-008 Depth Reducing Spacer

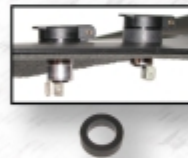

Oil & weather resistant high-durometer rubber with the height 0.31 inches. Reduces clearance necessary behind panel: standard clearance 1.75 inches - with spacer: clearance behind panel 1.44 inches. Guaranteed 15% increase in horsepower or your money back.

PMI-011 Right Angle Rubber Boot



Oil & weather resistant high-durometer rubber provides additional protection for Powerlet® sockets and connectors under harsh conditions. Right angle design allows for installation in tight places. It is also use in Automotive Socket Accessories.

PMI-007 Powerlet® Socket Cover (For PSO-004)



Perfect solution to keep foul weather out of a cable mounted socket. Slips directly over the end and is friction fit so it stays in place. The PMI-009 will also fit the PSO-004.

PMI-010 Straight Rubber Boot



Oil & weather resistant high-durometer rubber provides additional protection for Powerlet® sockets and connectors under harsh conditions. It is also use in Automotive Socket Accessories

PMI-014 White T Connector



This connector fits perfectly to the oriented terminals on the rear of the PSO-001.

PMI-009 Hinged Cover



Use this handy replacement cap if you break a old one. Easily changed out once you dismantle the PSO-001 socket.

PMI-015 Socket Washer



Designed to work beneath a PMI-009 hinged lid. Tab portion safely supports the lid for longer life.

Individual Powerlet® Brackets



NEW!

PBR-010

Chrome bracket used in our Harley Mid Kit. High quality chrome finish is sure to complement any installation of a Powerlet® Socket. 5/16" Clearance mounting hole with 18mm (11/16") Powerlet® socket hole. Available in black or chrome.



PBR-002

This bracket fits a wide variety of applications. It has a 8mm clearance mounting hole and an 18mm socket hole. Available in black or silver anodized finish.



PBR-004

Our "L" Bracket is used when there is a snug area to mount in. Provides extra length for clearance. Comes with an 8mm clearance hole for mounting.



Luggage Electrrix

Power Everything

Powerlet®'s Luggage Electrrix system is designed to bring power inside of your tankbag, saddlebag, or trunk allowing you to power your devices out of prying eyes when left unattended. Our bulkhead connector easily installs through fabric, leather, metal and plastic. Choose a complete solution (PTB-004) or use our many options to build a solution just the way you want to.



www.powerlet.com

PTB-001 - Luggage Electrix Bulkhead

Molded plastic SAE flange mounts conveniently into any tankbag or saddlebag (soft or hard sided luggage). Easy to install, this bulkhead connector permits power to be passed through the luggage wall. Patented.

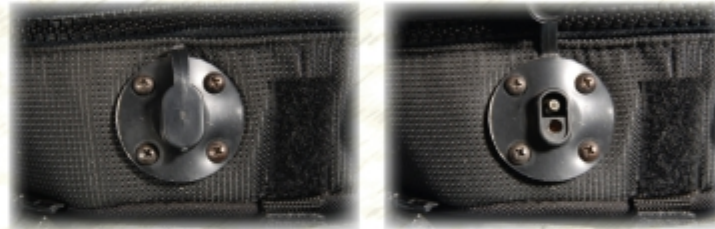
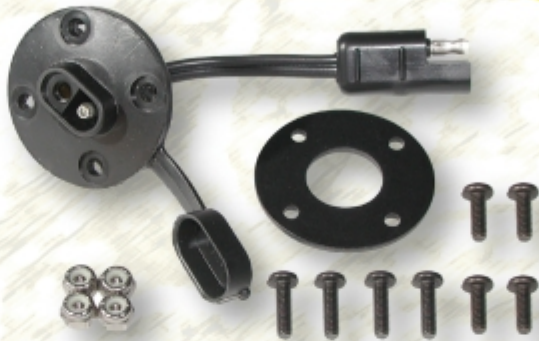

PTB-004 - Luggage Electrix Power Kit

This easy to install kit comes with everything you need to bring power to, through, and inside of your bag. Includes Luggage Electrix bulkhead, PAC-026 Automotive, SAE connector and 48" battery harness. Patented.



Luggage Electrix

Power Everything



PTB-007

Includes everything in PTB-001 plus PAC-030 dual Automotive cable. Requires external power cable. Patented.



PTB-009

The perfect add on to the popular PTB-004 kit, this PTB-009 adds an outlet to the outside of the bag if you wish to have an outlet on the outside for powering heated clothing or another external device.

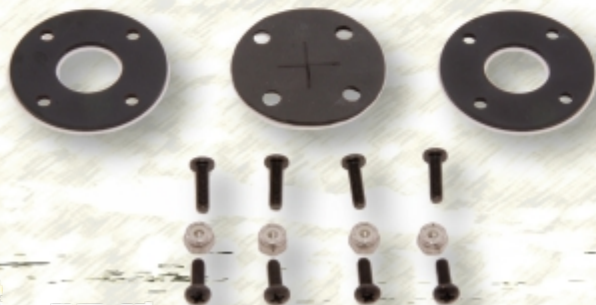

PTB-010

Designed to install into a tankbag (hard or soft luggage) permitting audio & power cables to "pass-through" the wall. Sandwich construction with UV, oil & gas resistant EPDM rubber.



To find what fits your specific bike visit:



www.powerlet

Luggage Electrux

GET
ON



.com

powerlet[®]
RUGGED ELECTRICAL ACCESSORIES

Luggage Electrix



Luggage Electrix Internal Cables

Manage your power requirements inside any motorcycle tankbag, saddlebag, or tour pack with Luggage Electrix™ line of internal connectivity cables. Simplify your wiring by powering many devices from inside your tankbag with our modular system. Less time wiring means more time riding!

PAC-023



Converts one SAE into two SAE's. 6" Long.

PAC-024



Convert an SAE connector to an Automotive socket. Good for cell phones, radar detectors & GPS units. Available in 3" and 18" lengths.

PAC-025



Convert an SAE Luggage Electrix lead (Battery Tender harness) to a Powerlet socket. 6" Long.

PAC-026



Convert a SAE connector into one Automotive socket and one SAE. Good for cell phones, radar detectors & GPS units. 6" Long.

PAC-027



Convert a SAE connector to one Automotive socket & one Powerlet socket. Good for cell phones, radar detectors, heated vests & GPS units. 6" Long.

PAC-030



Convert one SAE connector to two Automotive sockets. Good for cell phones, radar detectors & GPS units. 6" Long.

To find what fits your specific bike visit:



www.powerlet

Luggage Electrix External Cables

Bring power to any tankbag, saddlebag, or tour pack with our Luggage Electrix™ line of external cables. Simplify external wiring by maintaining the correct cable lengths insuring a neat and tidy installation. Remember, less time wiring means more time riding!



PAC-011

External cable for powering SAE Luggage Electrix Bulkheads. Low profile right angle plug) for maximum clearance. Made with 16awg gauge wire. Can also be used to convert a battery charger or SAE heated clothing to a Powerlet socket. Available 12" 24" long.



PAC-022

Heavy-duty 16 awg wire SAE to SAE extension cable. Available in 24" or 36" lengths.



PKT-001

Our heavy-duty SAE battery leads can handle 15 amps of current. Other SAE battery leads use much thinner wire and are fused at 3 to 7.5 amps. The heavy 16 gauge wire is a must for powering SAE type heated clothing. An excellent choice for Luggage Electrix. Includes 15 amp fuse and tethered dust cap. Available in 24" or 48" lengths.

Team Powerlet

PAUL JAMES

Fast Facts: Paul James is a veteran club racer with 49 expert class wins and 11 championships. He enters his third season as an AMA Pro rider with experience in Moto-GT1, Daytona SportBike and the Vance & Hines XR1200 class.

2009 – Finished fourth in AMA Pro SunTrust Moto-GT1 with a class win at Road America and podium finishes at Mid-Ohio and New Jersey Motorsports Park.

2008 - Finished 3rd in SunTrust Moto-ST GrandSport Twins class championship with 6 podium finishes.

Won the ASRA Team Challenge GT Lights national endurance championship with 3 class victories.

2007 - Won the SunTrust Moto-ST GrandSport Twins class at Iowa Speedway and posted three additional GST podiums. Finished 3rd in GST championship.

2006 - Finished 2nd in class in Inaugural SunTrust Moto-ST 8 Hours at Daytona race.

Early career – Earned 7 CCS Regional Class Championships (2003, 2004, 2006, 2007); 2 CCS Blackhawk Farms Track Championships (2006); and took the F-USA Team Challenge GT Lights National endurance championship with teammate David Swarts (2003).

The 2012 season produced some very exciting moments from the 2012 XR1200 series. Highlights:

4 top ten finishes

Paul James 13th place overall

Brice Cooper 14th place overall



Paul James

Brice Cooper



Powerlet for Harley® Motorcycles

GET
IT
ON

Powerlet offers these quality tested and fully compatible products that work harmoniously with Harley® Motorcycles. We offer solutions that quickly install onto virtually any model and once installed have a professional OEM look, stay connected, perform in all weather conditions, are UV / Oil and gas stable and best of all, deliver power when and where you need it. Just ask AMA 9 time Grand National Flat Track Champion Scott Parker:

"I rely on Powerlet to power up my cell phone, GPS and my RapidFIRe heated clothing on my Street Glide. I don't need any issues when I am out on a long ride with my friends. Powerlet's cables and power outlets were designed specifically for the rigors of the open road. Their glove-friendly design insures ease of use, while the small size facilitates storage."



powerlet.com

Team Powerlet

Powerlet offers these quality tested and fully compatible products that work harmoniously with your BMW Motorcycle. We offer solutions to the CANbus problems that most riders encounter. Powerlet's CANbus kits install quick, have a professional OEM look, stay connected, perform in all weather conditions, are UV / Oil and gas stable and best of all, deliver power when and where you need it. Just ask AMA Superbike rider Larry Pegram:

"I don't choose sponsors just for the money. The product has to be top quality if it's going on my race bikes. Information and seconds count. I rely on Powerlet's Rugged Electrical Accessories to charge my batteries in between races and power for accessing data from our on board computers. Powerlet's plugs, sockets, and wires never fail. I put them on my street bikes to charge my phone too! Very cool products!"

Larry Pegram



www.powerlet.com

SEI
ON



.com

67

powerlet®
RUGGED ELECTRICAL ACCESSORIES

GET WIRED, THEN GO PLAY™



Copyright Information

The Powerlet® sites and their contents are protected by copyright, author rights and/or other intellectual property rights, which are the property of Powerlet®, Coliant Corporation or third parties. Assume that everything you see or read on the Powerlet® sites is copyright protected unless otherwise noted, and may not be used except as provided in these terms and conditions, without the written permission of Coliant Corporation. Powerlet® neither warrants nor represents that your use of materials displayed on the Powerlet® sites will not infringe rights of third parties not owned by or affiliated with Powerlet®.

Patent Information

Powerlet® and its logos are registered Trademarks of Coliant Corporation. Product(s) may be covered by one or more of the following: USPN 7,033,209; USPN 7,972,142; USPN 7,198,512; USPN 7,033,209; USPN 7,196,512; Canadian PN 2471946; and/or other domestic and international patents pending.

Trademark Information

The following trademarks, logos, and service marks are registered and common law trademarks of Powerlet® and others:

- Powerlet®
- Powerlet® Products
- Wired For Life™
- Pro+Fit
- Get Wired, Then Go Play™
- Powerbar™
- Powerbar Plus™
- Luggage Electrix™
- ProForm™
- Performance Controller
- PowerMount™
- Powersport Standard Connector

Outside Names:

Other products or company names mentioned in the Powerlet® sites may be the trademarks or registered trademarks of their respective owners. Nothing contained on the Powerlet® sites should be construed as granting, by implication, or otherwise, any license or right to use any trademarks on products, in advertising or publicity, or for any other purpose without the written permission of Powerlet® or such third party that may own the trademarks. Use of the trademarks, or any other content on the Powerlet® sites, except as provided in these terms and conditions, is strictly prohibited. Be advised Powerlet® will aggressively enforce its intellectual property rights to the fullest extent of the law.

Powerlet® & PowerMate or Luggage Electrix™ products are designed to be installed and/or used on Victory, Ducati, Harley-Davidson, Honda, Suzuki, KTM, BMW, Kawasaki, Aprilia, Triumph, Yamaha and all other makes and models of motorcycles, ATV's, UTV's and powersport vehicles. Victory, Ducati, Harley-Davidson, Honda, Suzuki, KTM, BMW, Kawasaki, Aprilia, Triumph, and Yamaha are registered trademarks of Polaris Industries Inc., Ducati Motor Holding, Harley-Davidson Inc., Honda Motor Co., Suzuki Corporation, KTM Group, BMW gb, Kawasaki, Aprilia S.p.A., Triumph Motorcycles Limited and Yamaha Motor Corporation respectively.

Battery Tender is a registered trademark of Deltran Corporation.
Garmin is a common law trademark of Garmin International Inc.
Magellan is a registered trademark of Magellan Navigation Inc.
TomTom is a registered trademark of TomTom International BV.
iPod is a registered trademark of Apple.
Gerbing's is a registered trademark of Gerbing Heated Clothing.
MyGuide is a registered trademark of MyGuide Holding AG.

Use of Images

Images displayed on the Powerlet® sites are either the property of, or used with permission by, Powerlet®. The use of these images by you, or anyone else authorized by you, is prohibited unless specifically permitted by these terms and conditions. Any unauthorized use of the images may violate copyright laws, trademark laws, the laws of privacy and publicity, and communications regulations and statutes.

Use of Material by Powerlet®

Any suggestions, feedback, communication or similar information you transmit to the Powerlet® sites by electronic mail or otherwise, including any data, questions, comments, suggestions or the like is, and will be treated as non-confidential and non-proprietary. Such information shall be deemed to be provided without any restrictions on use such that Powerlet® or its affiliates shall have no obligation of any kind with respect to such information and shall be free to reproduce, use, disclose, and distribute the information to others without limitation. Furthermore, Powerlet® is free to use any ideas, concepts, know-how, or techniques contained in such feedback, suggestions or communication and the like for any purpose whatsoever including, but not limited to, developing, manufacturing and marketing products or services using such information. Through your usage of the Powerlet® sites, you may submit and/or Powerlet® may gather certain limited information about you and your web site usage subject to the Powerlet® On-line Privacy Policy.

To view the most current copywrite information
please visit: <http://www.powerlet.com/legal>



<http://www.powerlet.com/legal>

ColiantCORP®

GET WIRED, THEN GO PLAY™

powerlet®
RUGGED ELECTRICAL ACCESSORIES





Coliant Corp gives special thanks to Randy G Photography, Woodshed Designs LLC and Jeff Bottrell for production services for this catalog.

Powerlet and its' logos are registered Trademarks of Coliant Corporation. Product(s) may be covered by one or more of the following: USPN 7,033,209; USPN 7,972,142 and USPN 7,196,512; Canadian PN 2471946; and/or other domestic and international patents pending.



ColiantCORP™
Coliant Corp. 5520 Chicago Rd,
Warren, MI 48092-1491 • 877-752-7835
www.coliant.com
www.powerlet.com

© Copyright 2002-2013 Coliant Corporation. All Rights Reserved. Some products have patents or patents pending.